

**Gruppi di pompaggio con accumulo idrico
da 1 a 140 m³/h, da 100 a 1500 l**
**Pumping stations with water storage tank
from 1 to 140 m³/h, from 100 to 1500 l**

Vers.01/2018



CARATTERISTICHE GENERALI

Gruppi di pompaggio con accumulo idrico da abbinare a refrigeratori e pompe di calore per la produzione di acqua fredda e calda, per installazione interna o esterna. E' possibile la personalizzazione per potenza e capacità, sono completi di pompa, serbatoio di accumulo, componenti idraulici ed elettrici. Tutti i gruppi sono testati in fabbrica prima della consegna e necessitano dei soli collegamenti elettrici ed idraulici per la messa in opera.

GENERAL FEATURES

Pumping stations with water storage tank to combine to chiller and heat pump units for warm or cold water production, for indoor or outdoor installation. Possibility of personalization for capacity and power, they are completed with water pump, storage tank, all hydraulic and electrical components. All the units are tested in the factory before their delivery, for the installation they require only electrical and hydraulic connections.

CARATTERISTICHE COSTRUTTIVE E COMPONENTI PRINCIPALI

Struttura: in telaio portante, realizzata in lamiera zincata verniciata con polveri poliestere a forno, per resistere agli agenti atmosferici. Viti di acciaio.

Componenti idraulici: pompa centrifuga con corpo in acciaio inossidabile e motore elettrico monofase o trifase a 2 poli, accumulo idrico verticale, valvola di sicurezza, valvola di sfiato aria e rubinetto di scarico.

Quadro elettrico: costituito da interruttore automatico generale bloccoporta, interruttore magnetotermico di protezione e teleruttore pompa. Tutti i fili e morsetti sono numerati. In linea con la norma EN60204.

Pompa: centrifuga monofase/trifase, disponibile in 10 diversi modelli con tenuta meccanica per acqua e miscele con glicole superiore al 30%.

Accumulo: accumulo idrico verticale con isolamento termico esterno in poliuretano rigido. Finitura in lamierino di alluminio.

CAPACITA' 100-200-300-500-800-1000-1500 litri.

Valvola di sfiato aria: elimina l'aria presente nel circuito idrico.

Valvola di sicurezza: interviene quando nel circuito idrico si raggiunge una pressione eccessiva.

Rubinetto di scarico

TECHNICAL FEATURES AND MAIN COMPONENTS

Frame: Self-supporting galvanized steel sheet frame protected with polyester powder painting, to resist to the external agents. Steel screws and bolts.

Hydraulic components: centrifugal pump with stainless steel structure and single-phase electric motor or 2-pole three-phase, vertical water storage tank, safety valve, air vent valve and discharge faucet.

Electrical panel: composed of a general circuit breaker with door lock, automatic circuit breaker, remote control switch pump.

All wires and terminals are identified according to norm EN60204.

Pump: single-phase / three-phase centrifugal type available in 10 different models, with mechanical seal for either pure water or mixtures with glycol greater than 30%.

Storage tank: vertical water storage with rigid polyurethane insulation with external aluminum covering.

VOLUME 100-200-300-500-800-1000-1500 litres.

Relief valve: it eliminates the air in the hydraulic circuit.

Security valve: it intervenes when the pressure in the hydraulic circuit reach an excessive value.

Discharge faucet

SCHEMA TIPO IMPIANTO

PLAN EXAMPLE TYPE

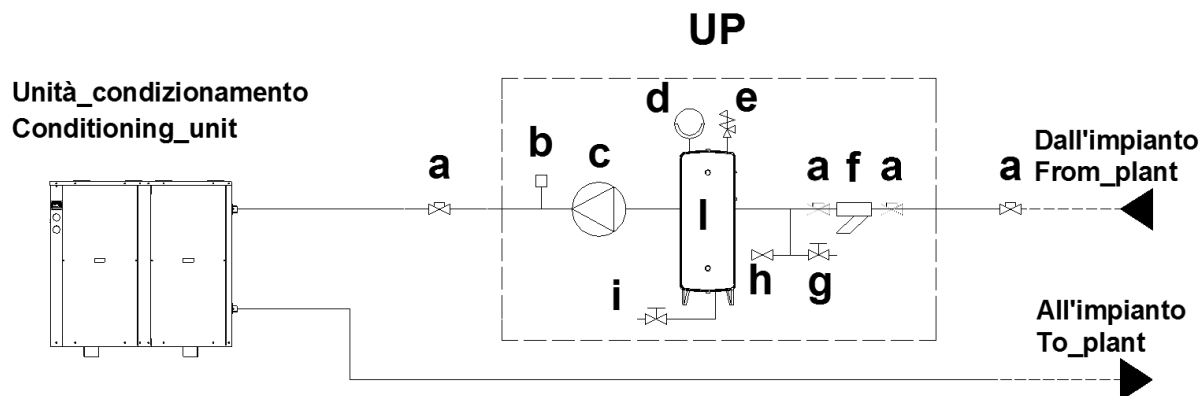

| | | | |
|----------|--|----------|---|
| a | RUBINETTO INTERCETTAZIONE - SHUT OFF FAUCET | f | FILTRO RETE - NET FILTER |
| b | PRESSOSTATO DIFFERENZIALE - DIFFERENTIAL PRESSURE SWITCH | g | PRESA DI CARICO - CHARGE VALVE |
| c | POMPA ACQUA - WATER PUMP | h | VALVOLA DI SICUREZZA - SECURITY VALVE |
| d | VASO ESPANSIONE - EXPANSION WESSEL | i | RUBINETTO DI SCARICO - DISCHARGE FAUCET |
| e | VALVOLA SFIATO ARIA - RELIEF VALVE | l | ACCUMULO IDRICO - WATER STORAGE TANK |

POMPA /ACCUMULO

PUMP/STORAGE TANK

| POMPA-PUMP | | ACCUMULO-STORAGE TANK | POMPA-PUMP | | ACCUMULO-STORAGE TANK |
|------------|------------|-----------------------|------------|------------|-----------------------|
| A | min/max L. | 100 - 300 | F | min/max L. | 300 - 750 |
| B | min/max L. | 100 - 300 | G | min/max L. | 500 - 1500 |
| C | min/max L. | 100 - 300 | H | min/max L. | 500 - 1500 |
| D | min/max L. | 200 - 800 | I | min/max L. | 800 - 1500 |
| E | min/max L. | 300 - 800 | L | min/max L. | 1000 - 1500 |

A richiesta si realizzano combinazioni con accumuli fino a 5000l - On demand it's possible to realize sizes with storage tank up to 5000l

ACCESSORI

ACCESSORIES

Filtro rete ingresso acqua: trattiene eventuali impurità nel circuito idrico, evitando il danneggiamento del gruppo di pompaggio e dello scambiatore. In ottone con attacchi filettati per le versioni 1" 1/4, 2", 2" 1/2, in ghisa con attacchi flangiati per le versioni DN 80-100-150 (fornito smontato). **Inlet water filter:** retains impurities of the water circuit which can damage the pumping unit and the exchanger. Brass with threaded connections for 1"1/4, 2" and 2"1/2 sizes, cast iron with flanged connection for DN 80-100-150 sizes (to assemble)



Pressostato differenziale lato acqua: funge da flussostato intervenendo quando la pressione scende sotto il valore minimo, fornito montato.

Differential pressure switch water side: it works as flow switch, it operates when pressure reach the minimum level (already mounted on board).



Vaso di espansione: assorbe le variazioni di volume subite dal liquido per effetto della variazione della temperatura di esercizio. In acciaio verniciato a polveri epossidiche di lunga durata con membrana fissa in gomma SBR. Capacità: 8 - 12- 24 litri. Fornito montato. **Expansion vessel:** absorbs liquid volume variations caused by working temperature variations. In epoxy powder coated steel, long-lasting duration with steady membrane made in SBR rubber. Capacity: 8 – 12 – 24 litres (already mounted on board).



Flussostato: Installato sull'uscita dello scambiatore lato utenza rileva l'eventuale assenza di flusso d'acqua segnalando l'allarme al sistema di controllo, (fornita smontata). **Flow switch:** mounted on the exit of the exchanger (user side) detects the water flow lack by an alarm to the control system (to assemble).



Kit doppia pompa: composto da 2 pompe di circolazione dotate di valvole non ritorno per evitare il ricircolo inverso di fluido attraverso la pompa in stand-by, completo di valvole a saracinesca a monte e valle di ciascuna pompa in modo da permettere la manutenzione senza fermi impianto. Le dimensioni della struttura variano per la versione a 2 pompe Su richiesta disponibile anche in versione senza accumulo su carpenteria ridotta. **Kit 2 pumps:** Double pump kit: consisting of 2 circulation pumps equipped with non-return valves to prevent the reverse flowing back through the pump in stand-by mode, complete with gate valves upstream and downstream of each pump so as to allow maintenance without latches plant. The frame change for the 2 pumps version. On demand is also available without storage tank on a smaller base frame.



Controllo sequenza fasi: verifica il corretto senso di rotazione della pompa, fornito all'interno del quadro elettrico. **Phase sequence control:** Checks the correct rotation direction of the pump, provided inside the electrical panel.



Antivibranti in gomma: riducono la trasmissione delle vibrazioni prodotte dalla macchina, forniti da montare. **Rubber antivibration isolation:** they reduce the vibrations transmission produced by the device. (to assemble)



CARATTERISTICHE TECNICHE

TECHNICAL FEATURES

| Modello Pompa – Pump Model | | A | B | C | D | E | F | G | H | I | L |
|--|-----------------|---------------|-------|------|---------------|------|-------|------|------|-------|-------|
| Potenza assorbita Absorbed power | kW | 0,50 | 0,55 | 0,75 | 1,10 | 1,50 | 2,20 | 3,00 | 4,00 | 7,50 | 11,00 |
| Corrente assorbita Absorbed current | A | 3,46 | 3,99 | 1,70 | 2,39 | 3,17 | 4,56 | 6,33 | 7,62 | 14,10 | 20,20 |
| Alimentazione elettrica - Electrical supply | V/Hz/ Ph | 230-50-1+N+PE | | | 400-50-3+N+PE | | | | | | |
| Connessioni idrauliche - Hydraulic connections | s/DN | 1"1/4 | 1"1/4 | 2" | 2" | 2" | 2"1/2 | 80 | 100 | 150 | 150 |

CURVE POMPE

PUMPS CURVES

Versione-Version A

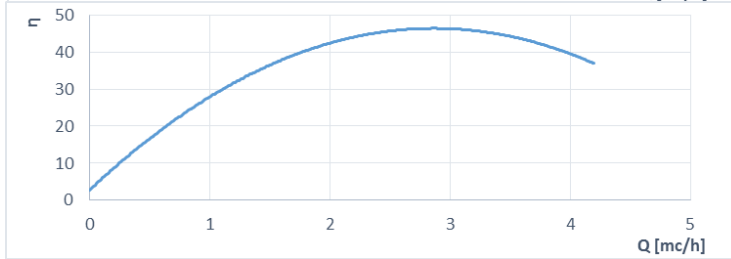
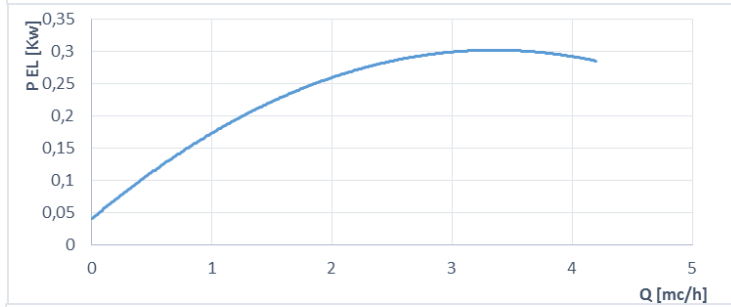
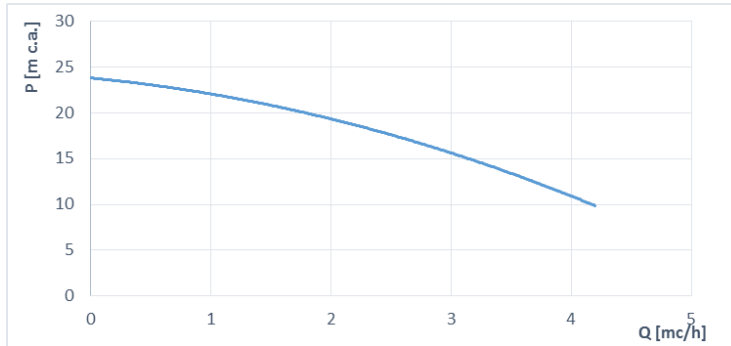

| | |
|-------------------|---|
| P (m c.a.) | Prevalenza (mt.colonna acq.) Head (m.water column) |
| Q (mc/h) | Portata acqua Water flow |
| P EL (kW) | Potenza elettrica ass. Absorbed power |
| η | Efficienza – Efficiency |

Versione-Version B

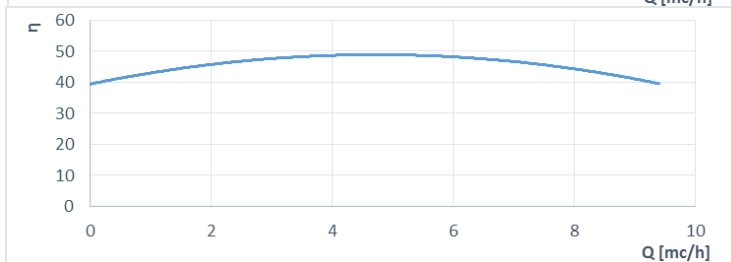
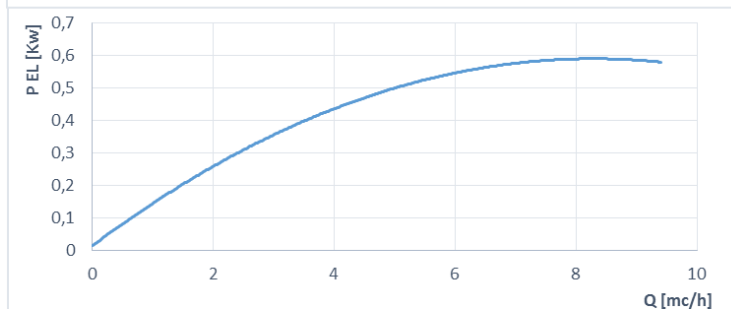
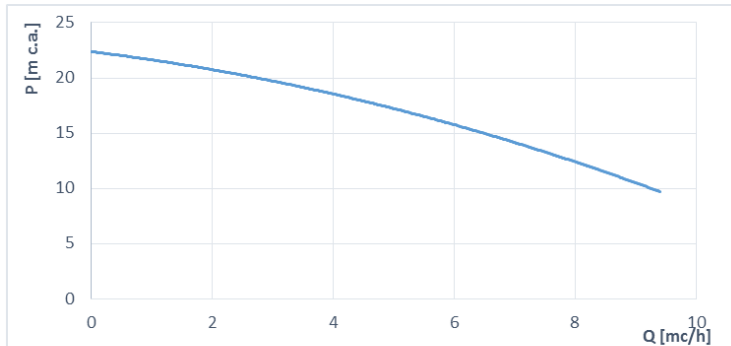

| | |
|-------------------|---|
| P (m c.a.) | Prevalenza (mt.colonna acq.) Head (m.water column) |
| Q (mc/h) | Portata acqua Water flow |
| P EL (kW) | Potenza elettrica ass. Absorbed power |
| η | Efficienza – Efficiency |

CURVE POMPE

PUMPS CURVES

Versione-Version C

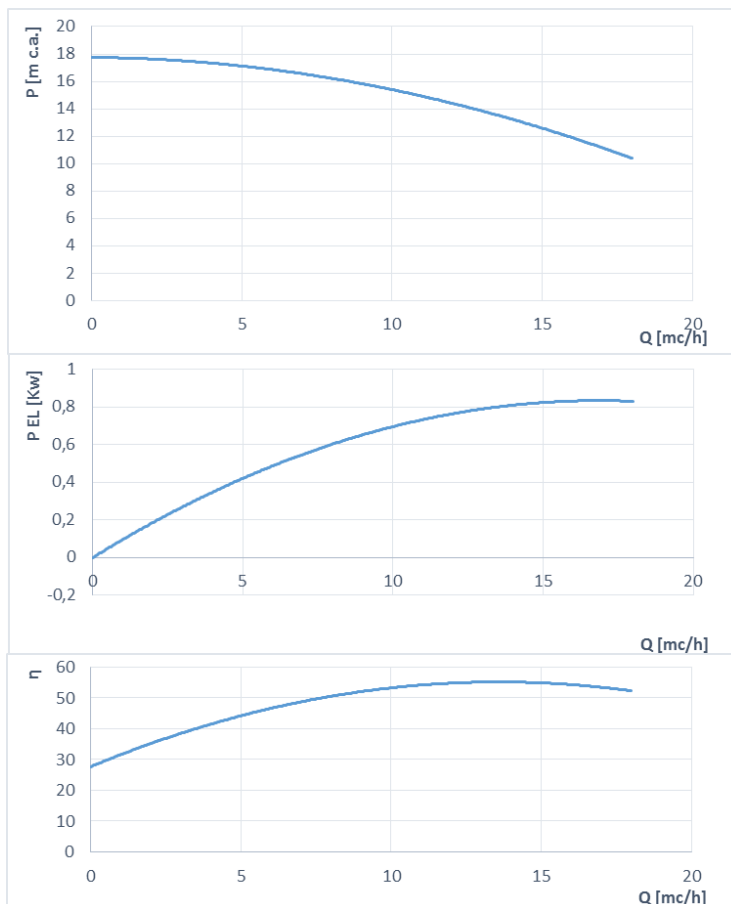

| | |
|-------------------|---|
| P (m c.a.) | Prevalenza (mt.colonna acq.) Head (m.water column) |
| Q (mc/h) | Portata acqua Water flow |
| P EL (kW) | Potenza elettrica ass. Absorbed power |
| η | Efficienza – Efficiency |

Versione-Version D

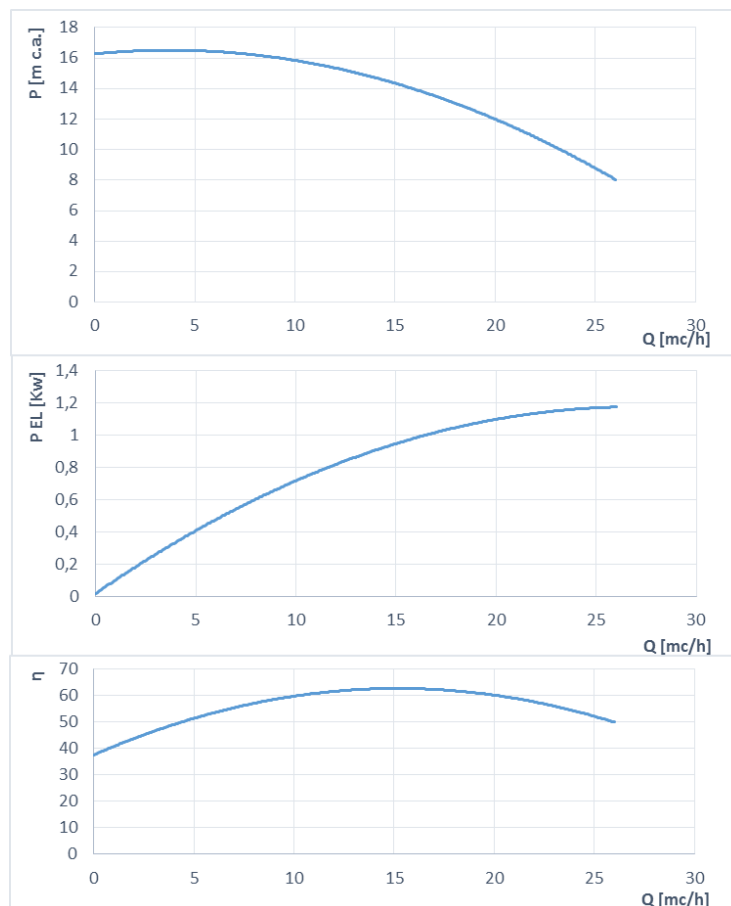

| | |
|-------------------|---|
| P (m c.a.) | Prevalenza (mt.colonna acq.) Head (m.water column) |
| Q (mc/h) | Portata acqua Water flow |
| P EL (kW) | Potenza elettrica ass. Absorbed power |
| η | Efficienza – Efficiency |

CURVE POMPE

PUMPS CURVES

Versione-Version E

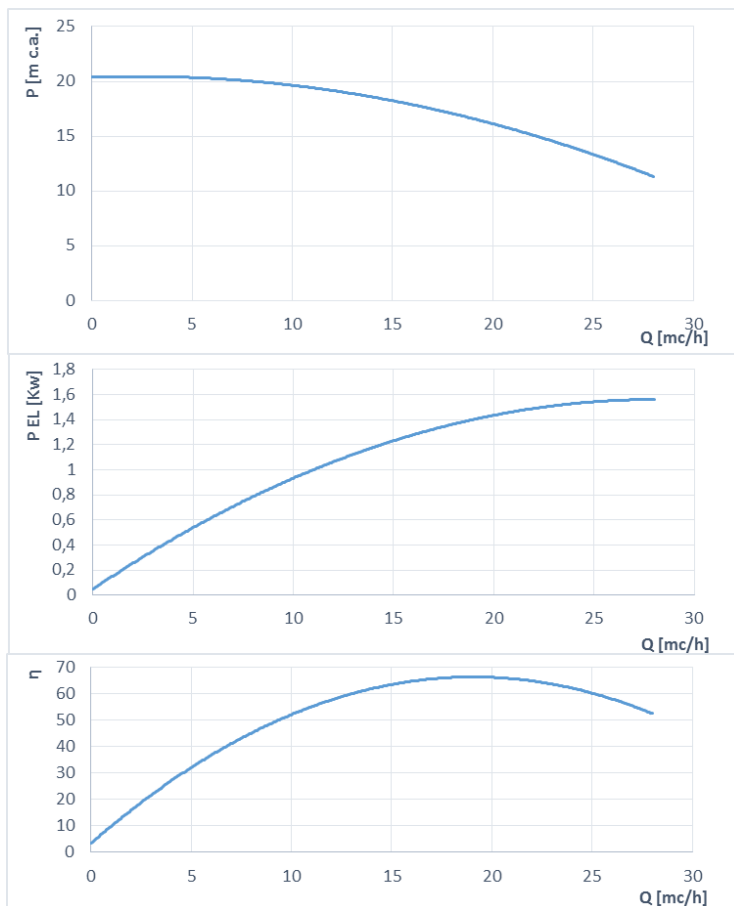

| | |
|-------------------|---|
| P (m c.a.) | Prevalenza (mt.colonna acq.) Head (m.water column) |
| Q (mc/h) | Portata acqua Water flow |
| P EL (kW) | Potenza elettrica ass. Absorbed power |
| η | Efficienza – Efficiency |

Versione-Version F

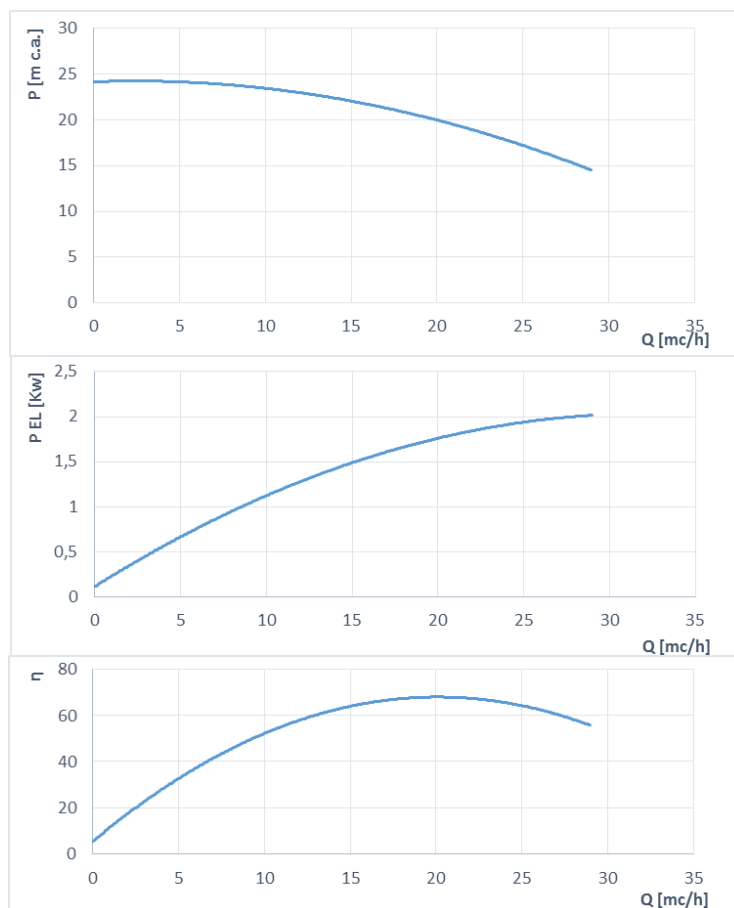

| | |
|-------------------|---|
| P (m c.a.) | Prevalenza (mt.colonna acq.) Head (m.water column) |
| Q (mc/h) | Portata acqua Water flow |
| P EL (kW) | Potenza elettrica ass. Absorbed power |
| η | Efficienza – Efficiency |

CURVE POMPE

PUMPS CURVES

Versione-Version G

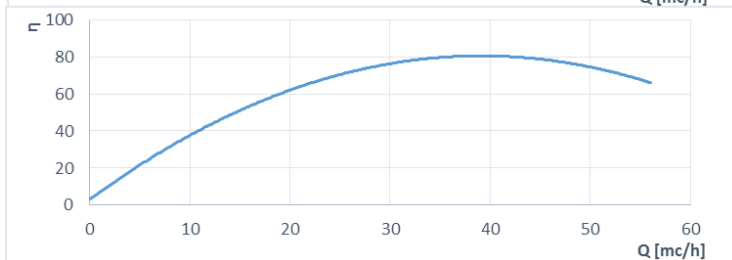
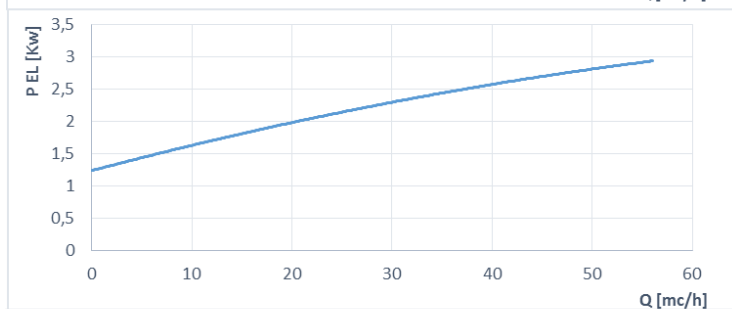
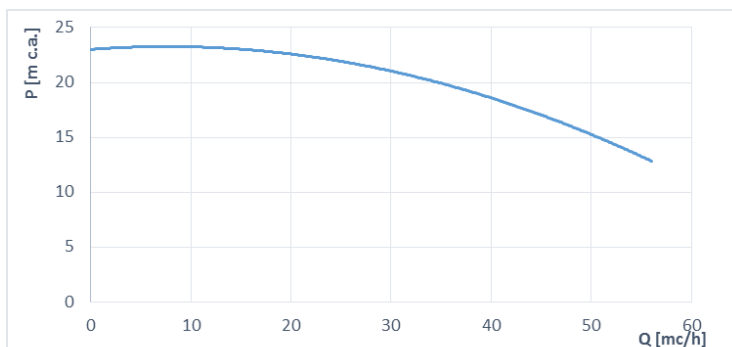

| | |
|-------------------|---|
| P (m c.a.) | Prevalenza (mt.colonna acq.) Head (m.water column) |
| Q (mc/h) | Portata acqua Water flow |
| P EL (kW) | Potenza elettrica ass. Absorbed power |
| η | Efficienza – Efficiency |

Versione-Version H

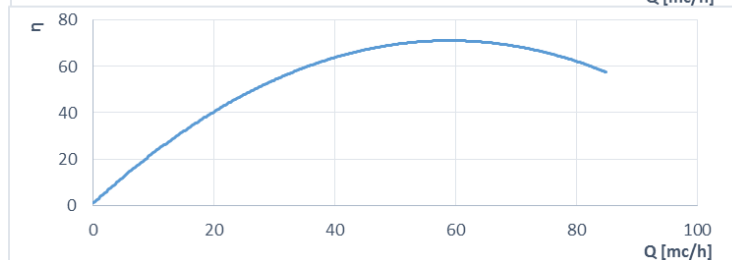
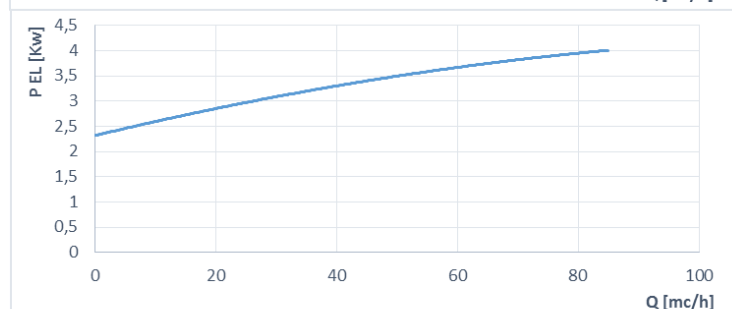
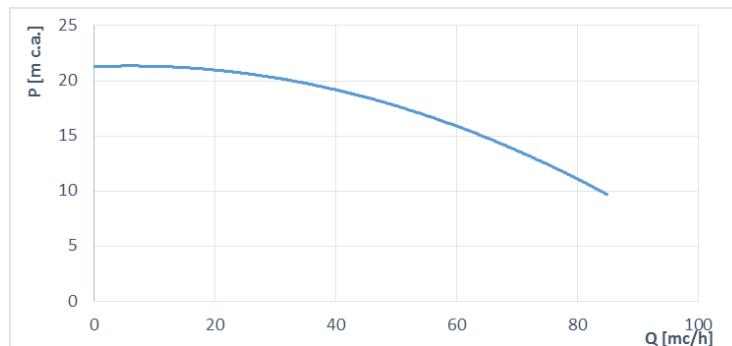

| | |
|-------------------|---|
| P (m c.a.) | Prevalenza (mt.colonna acq.) Head (m.water column) |
| Q (mc/h) | Portata acqua Water flow |
| P EL (kW) | Potenza elettrica ass. Absorbed power |
| η | Efficienza – Efficiency |

CURVE POMPE

PUMPS CURVES

Versione-Version I

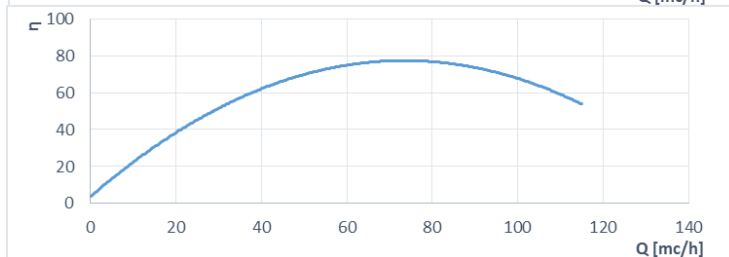
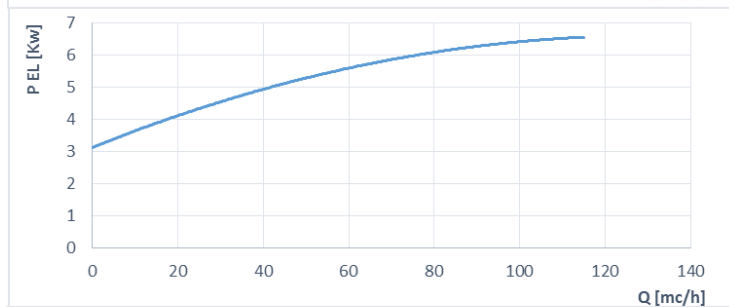
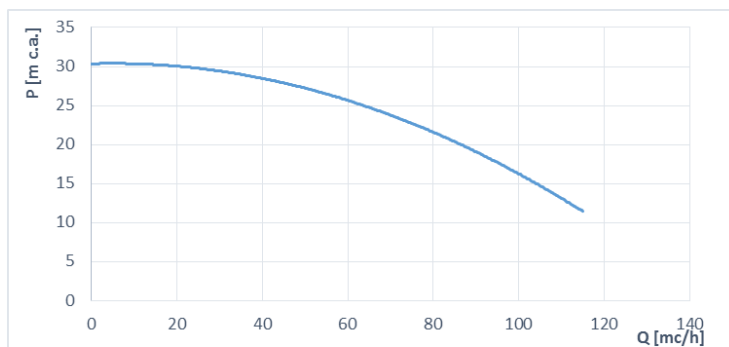

| | |
|-------------------|---|
| P (m c.a.) | Prevalenza (mt.colonna acq.) Head (m.water column) |
| Q (mc/h) | Portata acqua Water flow |
| P EL (kW) | Potenza elettrica ass. Absorbed power |
| η | Efficienza – Efficiency |

Versione-Version L

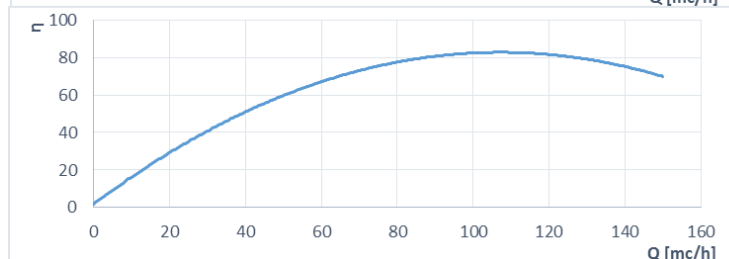
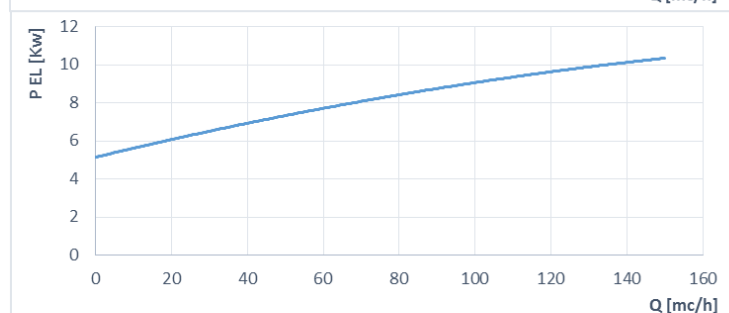
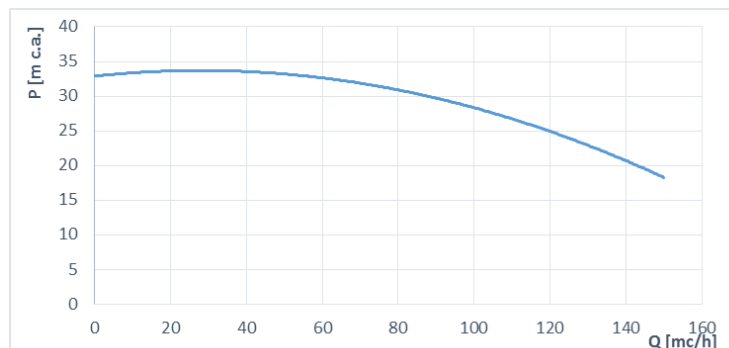

| | |
|-------------------|---|
| P (m c.a.) | Prevalenza (mt.colonna acq.) Head (m.water column) |
| Q (mc/h) | Portata acqua Water flow |
| P EL (kW) | Potenza elettrica ass. Absorbed power |
| η | Efficienza – Efficiency |

Accumulo-Storage tank 100-200-300
1 pompa-pump

Peso – Weight kg. 100
 Peso – Weight kg. 100
 Peso – Weight kg. 100

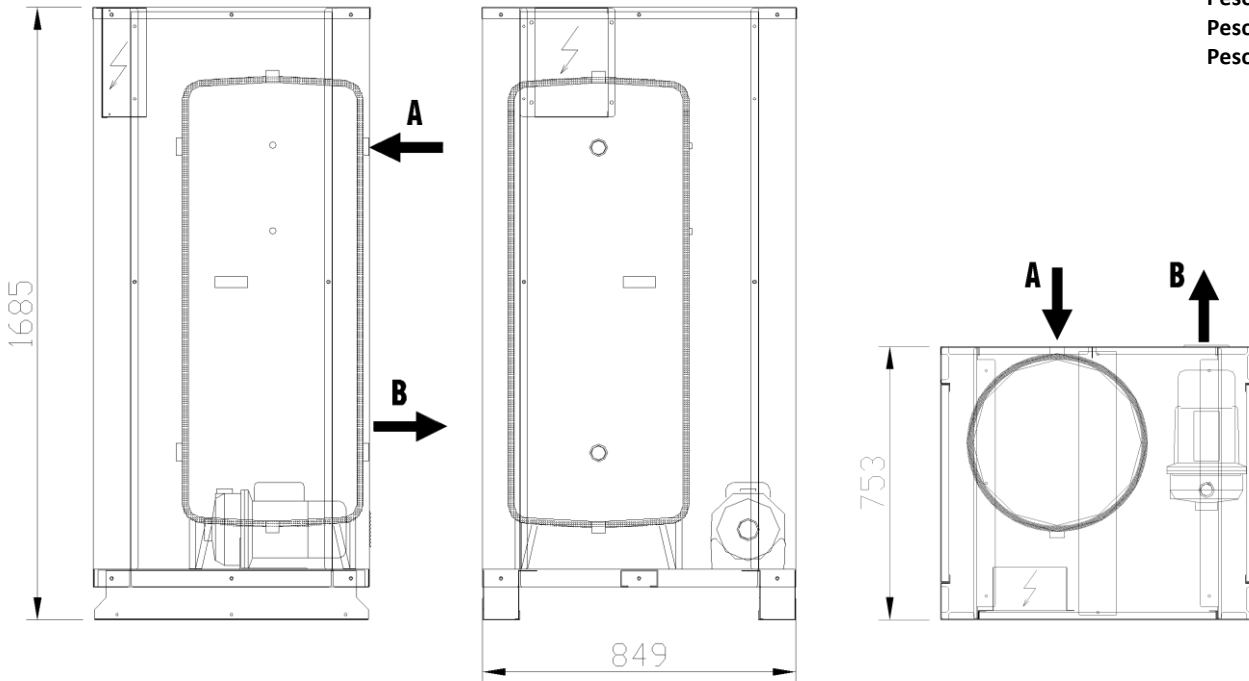

Accumulo-Storage tank 500-800
1 pompa-pump

Peso – Weight kg. 100
 Peso – Weight kg. 100

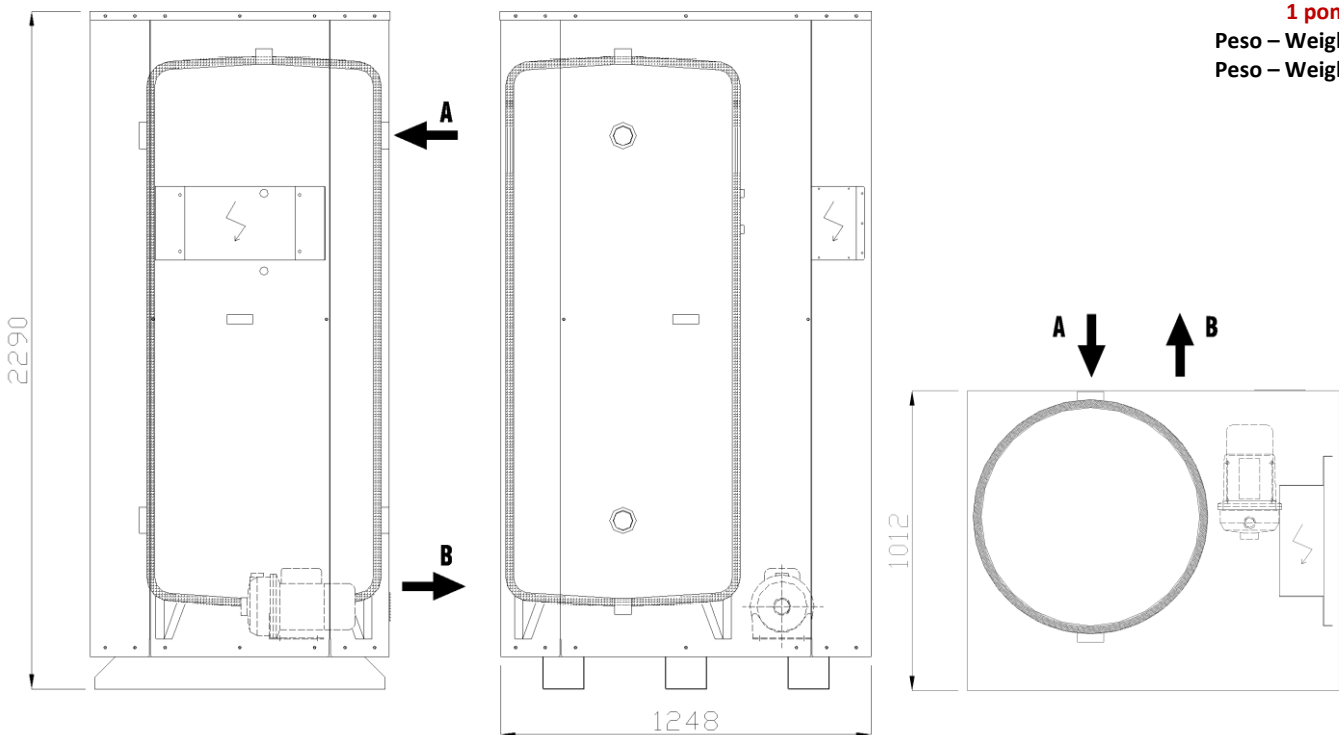

Accumulo-Storage tank 1000
1 pompa-pump
Peso – Weight kg. 100

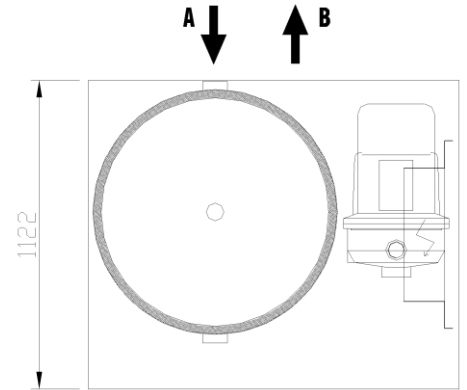
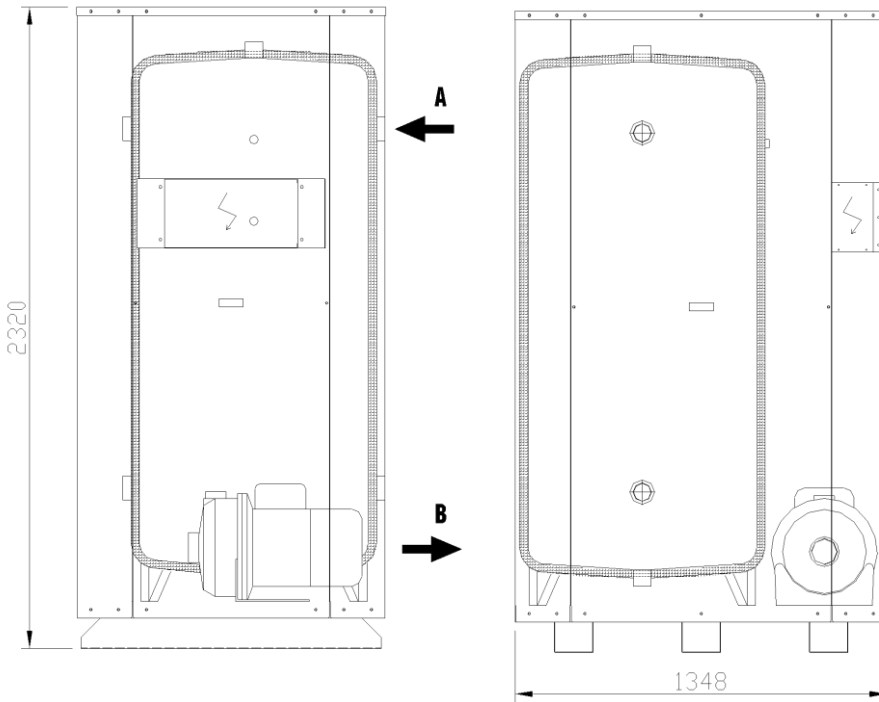

Accumulo-Storage tank 1500
1 pompa-pump
Peso – Weight kg. 100

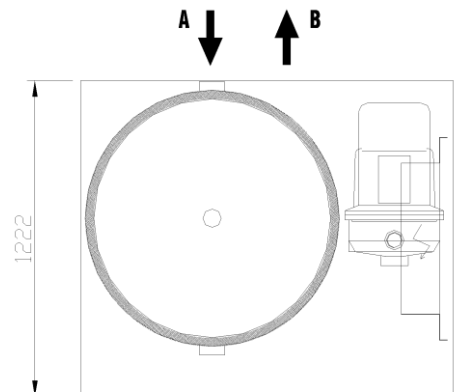
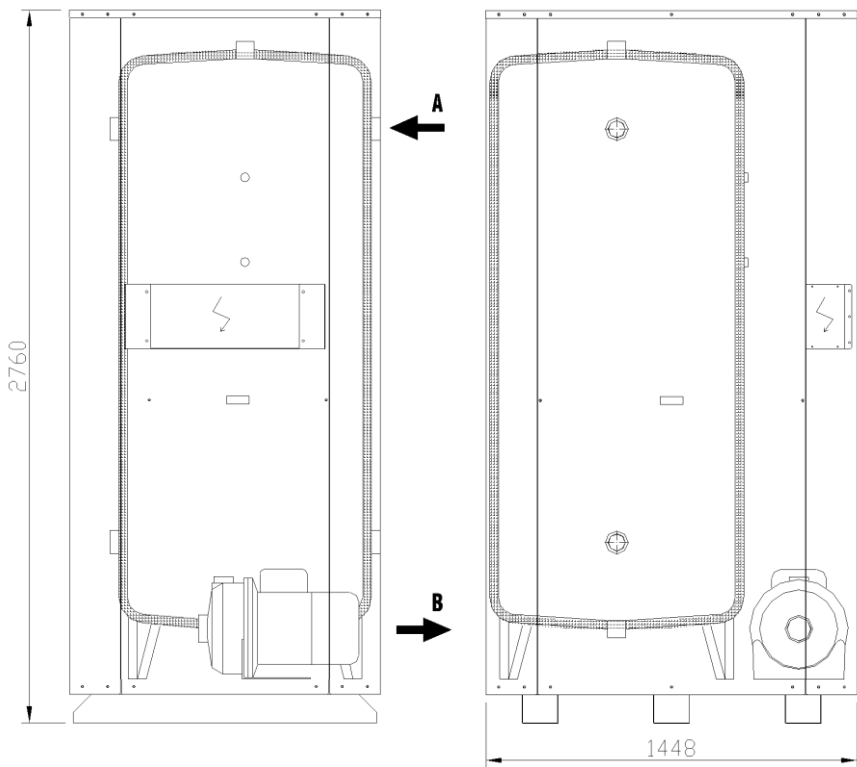

I dati tecnici presenti nel bollettino tecnico non sono impegnativi. La FROST ITALY S.r.l. si riserva la facoltà di apportare in qualsiasi momento tutte le modifiche ritenute necessarie al miglioramento del prodotto.

The technical present data in the technical bulletin are not binding. The FROST ITALY S.r.l. reserves the faculty of make in any moment all the modifications thought necessary to the improvement of the product.